

# Produktübersicht

2023





## NOVA FONTE Pura

				
Waschtisch-Einhandmischer 75 DN 15	Waschtisch-Einhandmischer 100 DN 15	Waschschüssel-Einhandmischer DN 15	Waschtisch-Zweiloch-Wand-Einhandmischer	Bidet-Einhandmischer DN 15
ohne Ablaufgarnitur 200280515 Chrom 200283915 Mattschwarz	ohne Ablaufgarnitur 200260515 Chrom 200263915 Mattschwarz	ohne Ablaufgarnitur 202980515 Chrom 202983915 Mattschwarz 202985315 Mattweiß	Ausladung 180 mm 202440515* Chrom 202443915* Mattschwarz 202445315* Mattweiß	mit Ablaufgarnitur 202160515 Chrom 202163915 Mattschwarz 202165315 Mattweiß
Push-Open 202660515 Chrom 202663915 Mattschwarz 202665315 Mattweiß	Push-Open 202880515 Chrom 202883915 Mattschwarz 202885315 Mattweiß		Ausladung 220 mm 202450515* Chrom 202453915* Mattschwarz 202455315* Mattweiß	

## NOVA FONTE Puristic

				
Waschtisch-Dreilocharmatur DN 15	Waschtischarmatur DN 15	Waschtisch-Wandarmatur DN 15	Bidetarmatur DN 15	Wannenfüll- und Brausearmatur DN 15
mit Ablaufgarnitur 201430515 Chrom 201433915 Mattschwarz	mit Ablaufgarnitur 201180515 Chrom 201183915 Mattschwarz	Ausladung 180 mm 201440515 Chrom 201443915 Mattschwarz	mit Ablaufgarnitur 203130515 Chrom 203133915 Mattschwarz	205400515 Chrom 205403915 Mattschwarz 205405315 Mattweiß
schwenkbarer (150° / 360°) oder arretierbarer Auslauf	schwenkbarer (150° / 360°) oder arretierbarer Auslauf	Ausladung 240 mm 201460515 Chrom 201463915 Mattschwarz		

				
Wannenfüll- und Brausearmatur DN 15	Wannenfüll- und Brausearmatur DN 15	Unterputz-Wannenfüll- und Brause-Einhandmischer	Unterputz-Wannenfüll- und Brause-Thermostatarmatur	PUSH Unterputz-Armatur
205900515** Chrom 205903915** Mattschwarz	204250515*** Chrom 204253915*** Mattschwarz	206590515*** Chrom 206593915*** Mattschwarz 206595315*** Mattweiß	208300515*** Chrom 208303915*** Mattschwarz 208305315*** Mattweiß	387120538*** Chrom
		eigensicher gegen Rückfließen 206630515*** Chrom 206633915*** Mattschwarz 206635315*** Mattweiß		



			
PUSH Unterputz-Thermostatarmatur	Brausearmatur DN 15	Unterputz-Brause-Einhandmischer	Unterputz-Brause-Thermostatarmatur
ein Verbraucher 389020538*** Chrom	207100515 Chrom 207103915 Mattschwarz 207105315 Mattweiß	206550515*** Chrom 206553915*** Mattschwarz 206555315*** Mattweiß	208350515*** Chrom 208353915*** Mattschwarz 208835315*** Mattweiß
zwei Verbraucher 389120538*** Chrom			

\* benötigtes Zubehör: Rohbau-Set DN 15, Art.-Nr. 38242 \*\* benötigtes Zubehör: KLUDI FLEXX.BOXX, Art.-Nr. 88088

\*\*\* benötigtes Zubehör: KLUDI FLEXX.BOXX, Art.-Nr. 88011

## NOVA FONTE Classic

				
Waschtisch-Dreilocharmatur DN 15	Waschtischarmatur DN 15	Waschtisch-Wandarmatur DN 15	Bidetarmatur DN 15	Wannenfüll- und Brausearmatur DN 15
mit Ablaufgarnitur 201430520 Chrom	mit Ablaufgarnitur 201180520 Chrom	Ausladung 180 mm 201440520 Chrom	mit Ablaufgarnitur 203130520 Chrom	205400520 Chrom
		Ausladung 240 mm 201460520 Chrom		

		
Wannenfüll- und Brausearmatur DN 15	Wannenfüll- und Brausearmatur DN 15	Brausearmatur DN 15
205900520* Chrom	204250520 Chrom	207100520 Chrom
schwenkbarer (150° / 360°) oder arretierbarer Auslauf		Ausladung 240 mm 201460515 Chrom 201463915 Mattschwarz

## NOVA FONTE Déco

				
Waschtisch-Dreilocharmatur DN 15	Waschtischarmatur DN 15	Waschtisch-Wandarmatur DN 15	Bidetarmatur DN 15	Wannenfüll- und Brausearmatur DN 15
mit Ablaufgarnitur 201430539 Chrom	mit Ablaufgarnitur 201180539 Chrom	Ausladung 180 mm 201440539 Chrom	203130539 Chrom	205400539 Chrom
		Ausladung 240 mm 201460539 Chrom		





		
Wannenfüll- und Brausearmatur DN 15	Wannenfüll- und Brausearmatur DN 15	Brausearmatur DN 15
205900539* Chrom	204250539 Chrom	207100539 Chrom

## BOZZ

				
Waschtisch-Einhandmischer 75 DN 15	Waschtisch-Einhandmischer 75 DN 15	Waschtisch-Einhandmischer 75 DN 15 Mittelstellung Kaltwasser	Waschtisch-Einhandmischer 100 DN 15 Mittelstellung Kaltwasser	Waschtisch-Einhandmischer DN 15
mit Ablaufgarnitur 382700576 Chrom	ohne Ablaufgarnitur 382720576 Chrom 382723976 Mattschwarz	ohne Ablaufgarnitur 3,8l Durchflussmenge 383890576WR4 Chrom 383893976 Mattschwarz	mit Ablaufgarnitur 3,8l Durchflussmenge 382930576WR4 Chrom 382933976 Mattschwarz	mit Ablaufgarnitur 380270576 Chrom
für drucklose Speicher 382770576 Chrom	Push-Open 382660576 Chrom 382663976 Mattschwarz 382665376 Mattweiß	5l Durchflussmenge 381980576WR4 Chrom 381983976 Mattschwarz		ohne Ablaufgarnitur 380280576 Chrom 380283976 Mattschwarz 380285376 Mattweiß

				
Waschtisch-Einhandmischer DN 15	Waschschüssel-Einhandmischer DN 15	Unterputz-Waschtisch-Zweiloch-Wand-Einhandmischer	Standventil	Standventil mit Kopfsteuerung DN 15
mit Ablaufgarnitur 382940576 Chrom	ohne Ablaufgarnitur 382860576 Chrom 382863976 Mattschwarz 382865376 Mattweiß	Ausladung 180 mm 382440576* Chrom 382443976* Mattschwarz 382445376* Mattweiß	ohne Ablaufgarnitur 381180576 Chrom 381183976 Mattschwarz	ohne Ablaufgarnitur 380160530 Chrom
		Ausladung 230 mm 382450576* Chrom 382453976* Mattschwarz 382455376* Mattweiß		

				
Standventil DN 15	Bidet-Einhandmischer DN 15	Wannenfüll- und Brause-Einhandmischer DN 15	Wannenfüll- und Brausearmatur DN 15	Wannenfüll- und Brause-Einhandmischer DN 15
ohne Ablaufgarnitur 381160530 Chrom	mit Ablaufgarnitur 385330576 Chrom 385333976 Mattschwarz 385335376 Mattweiß	386910576 Chrom 386913976 Mattschwarz 386915376 Mattweiß	385900576** Chrom 385903976** Mattschwarz	384480576 Chrom

			
Unterputz-Wannenfüll- und Brause-Einhandmischer	PUSH Unterputz-Armatur	PUSH Unterputz-Thermostatarmatur	Wanneneinlauf DN 20
386590576*** Chrom 386593976*** Mattschwarz 386595376*** Mattweiß	387120538*** Chrom	ein Verbraucher 389020538*** Chrom	3850505 Chrom 3850539 Mattschwarz 3850553 Mattweiß
386630576*** Chrom 386633976*** Mattschwarz 386635376*** Mattweiß		zwei Verbraucher 389120538*** Chrom	6l Durchflussmenge 412980575 Chrom

\* benötigtes Zubehör: KLUDI FLEXX.BOXX, Art.-Nr. 88088

\* benötigtes Zubehör: Rohbau-Set DN 15, Art.-Nr. 38243 \*\* benötigtes Zubehör: KLUDI FLEXX.BOXX, Art.-Nr. 88088

\*\*\* benötigtes Zubehör: KLUDI FLEXX.BOXX, Art.-Nr. 88011

## BOZZ



Brause-Einhandmischer  
DN 15

Thermostat  
Brausearmatur DN 15

Unterputz-Brause-  
Einhandmischer

388310576 Chrom  
388313976 Mattschwarz  
388315376 Mattweiß

352030538 Chrom  
352033938 Mattschwarz  
352035338 Mattweiß

386550576\* Chrom  
386553976\* Mattschwarz  
386555376\* Mattweiß

## LOUVA verfügbar ab Juli 2023



Waschtisch-Einhand-  
mischer 75 DN 15

Waschtisch-Einhand-  
mischer 100 DN 15

Waschtisch-Einhand-  
mischer 100 ECO PLUS

Waschschüssel-Einhand-  
mischer

Waschtisch-Zweiloch-  
Wand-Einhandmischer

ohne Ablaufgarnitur  
242720575 Chrom  
242723975 Mattschwarz  
242725375 Mattweiß

ohne Ablaufgarnitur  
242820575 Chrom  
242823975 Mattschwarz  
242825375 Mattweiß

Push-Open  
242660575 Chrom  
242663975 Mattschwarz  
242665375 Mattweiß

ohne Ablaufgarnitur  
242860575 Chrom  
242863975 Mattschwarz  
242865375 Mattweiß

Ausladung 220 mm  
242450575\*\* Chrom  
242453975\*\* Mattschwarz  
242455375\*\* Mattweiß

Push-Open  
242660575 Chrom  
242663975 Mattschwarz  
242665375 Mattweiß

Push-Open  
242880575 Chrom  
242883975 Mattschwarz  
242885375 Mattweiß

Push-Open  
242630575 Chrom  
242633975 Mattschwarz  
242635375 Mattweiß



Unterputz-Wannenfüll-  
und Brause-Einhand-  
mischer

Unterputz-Brause-  
Einhandmischer

Unterputz-Wannenfüll-  
und Brause-Thermostat-  
armatur

Unterputz-Brause-  
Thermostatarmatur

Wannenfüll- und  
Brausearmatur

247590575\*\*\* Chrom  
247593975\*\*\* Mattschwarz  
247595375\*\*\* Mattweiß

247550575\*\*\* Chrom  
247553975\*\*\* Mattschwarz  
247555375\*\*\* Mattweiß

248300575\*\*\* Chrom  
248303975\*\*\* Mattschwarz  
248305375\*\*\* Mattweiß

248350575\*\*\* Chrom  
248353975\*\*\* Mattschwarz  
248355375\*\*\* Mattweiß

246910575 Chrom  
246913975 Mattschwarz  
246915375 Mattweiß

eigensicher gegen  
Rückfließen  
247630575\*\*\* Chrom  
247633975\*\*\* Mattschwarz  
247635375\*\*\* Mattweiß



Brausearmatur

248310575 Chrom  
248313975 Mattschwarz  
248315375 Mattweiß

## ZENTA SL



Waschtisch-Einhand-  
mischer 75 DN 15

Waschtisch-Einhand-  
mischer 75 DN 15

Waschtisch-Einhand-  
mischer 75 DN 15  
Mittelstellung Kaltwasser

Waschtisch-Einhand-  
mischer 100 DN 15

Waschtisch-Einhand-  
mischer 100 DN 15

mit Ablaufgarnitur

mit Ablaufgarnitur  
für drucklose Speicher

mit Ablaufgarnitur

mit Ablaufgarnitur

482600565 Chrom

482770565 Chrom

3,8l Durchflussmenge  
483890565WR4 Chrom  
483893965 Mattschwarz

482900565 Chrom  
482903965 Mattschwarz

ohne Ablaufgarnitur  
482620565 Chrom

Push-Open  
482660565 Chrom  
7l Durchflussmenge

482630565 Chrom  
482633965 Mattschwarz

ohne Ablaufgarnitur  
482920565 Chrom

Push-Open  
482980565 Chrom  
482983965 Mattschwarz

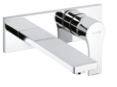

Waschtisch-Einhand-  
mischer 100 DN 15  
Mittelstellung Kaltwasser

Waschtisch-Einhand-  
mischer 100 DN 15

Waschtisch-Einhand-  
mischer DN 15

Waschschüssel-Einhand-  
mischer DN 15

Unterputz-Waschtisch-  
Zweiloch-Wand-  
Einhandmischer

mit Ablaufgarnitur

mit Ablaufgarnitur  
3,8l Durchflussmenge  
482900565WR5 Chrom

mit Ablaufgarnitur

ohne Ablaufgarnitur

Ausladung 180 mm

482930565WR4 Chrom  
482933965 Mattschwarz

480270565 Chrom  
480273965 Mattschwarz

482560565 Chrom  
482563965 Mattschwarz

482470565\* Chrom  
482473965\* Mattschwarz

ohne Ablaufgarnitur

ohne Ablaufgarnitur

ohne Ablaufgarnitur  
3,8l Durchflussmenge  
482560565WR5 Chrom

Ausladung 230 mm

481980565WR4 Chrom  
481983965 Mattschwarz

480280565 Chrom

482480565\* Chrom



Unterputz-Waschtisch-  
Zweiloch-Wand-  
Einhandmischer

Waschtischarmatur  
DN 15

Elektronische Wasch-  
tischarmatur DN 15  
mit Mischwelle

Elektronische Wasch-  
tischarmatur DN 15  
mit Mischwelle +  
Temperaturwählgriff

Elektronische Wasch-  
tischarmatur DN 15

Ausladung 180 mm  
482440565\* Chrom

483930565 Chrom

230V Netzgerät  
3820205 Chrom

230V Netzgerät  
3820005 Chrom  
3820039 Mattschwarz

230V Netzgerät  
3820505 Chrom

Ausladung 230 mm  
482450565\* Chrom

6V Lithium-Batterie  
3810205 Chrom

6V Lithium-Batterie  
3810005 Chrom  
3810039 Mattschwarz

6V Lithium-Batterie  
3810505 Chrom



Elektronische Wasch-  
tischarmatur DN 15  
Auslaufhöhe 230 mm

Elektronische Wasch-  
tischarmatur DN 15  
1,9l Durchflussmenge

Elektronische Wasch-  
tischarmatur DN 15  
3,8l Durchflussmenge

Elektronische Wasch-  
tischarmatur DN 15  
Temperaturwählgriff

Elektronische Wasch-  
tischarmatur DN 15

230V Netzgerät  
3820005WR Chrom

Ausladung 190 mm  
3850005\*\* Chrom

Ausladung 190 mm  
3850205\*\*\* Chrom

6V Lithium-Batterie  
3810005WR Chrom  
3810039WR Mattschwarz

6V Lithium-Batterie  
3810005R Chrom

Ausladung 240 mm  
3840005\*\* Chrom  
3840039\*\* Mattschwarz

Ausladung 240 mm  
3840205\*\*\* Chrom

\* benötigtes Zubehör: FLEXX.BOXX, Art.-Nr. 8801 \*\* benötigtes Zubehör: Rohbau-Set DN 15, Art.-Nr. 38242





\*\*\*benötigtes Zubehör: SLIM.BOXX, Art.-Nr. 88022





\* benötigtes Zubehör: Rohbau-Set DN 15, Art.-Nr. 38243 oder Art.-Nr. 38242 \*\* benötigtes Zubehör: Elektronik-Körper mit Netzteil, Art.-Nr. 38001 oder





Elektronik-Körper mit Batterie, Art.-Nr. 38002 \*\*\* benötigtes Zubehör: Elektronik-Körper mit Netzteil, Art.-Nr. 38003 oder Elektronik-Körper mit Batterie, Art.-Nr. 38004

## ZENTA SL

			
Elektronische Waschtischarmatur DN 15 mit Temperaturgriff	Elektronische Waschtischarmatur DN 15	Elektronische Waschtischarmatur DN 15 Temperaturwählgriff 1,9l Durchflussmenge	Service-Fernbedienung für elektronische Armaturen
Ausladung 190 mm 3850105* Chrom	Ausladung 190 mm 3850305** Chrom	Ausladung 190 mm 3850305WR* Chrom	7679000-00 neutral
Ausladung 240 mm 3840105* Chrom	Ausladung 240 mm 3840305** Chrom	Ausladung 240 mm + 3840105WR* Chrom	kompatibel für: 3810005, 3810005WR, 3810005R, 3810039, 3810039WR, 3820005, 3820005WR, 3820039, 3810205, 3820205, 3810505, 3810605, 3820505, 3840005, 3850005, 3840205, 3850205, 3840105, 3850105, 3840305, 3850305, 3850205, 3840105, 3850105, 3840305, 3850305

				
Bidet-Einhandmischer DN 15	Wannenfüll- und Brause-Einhandmischer DN 15	Thermostat Wannenfüll- und Brausearmatur DN 15	Wannenfüll- und Brausearmatur DN 15	Wannenfüll- und Brausearmatur DN 15
485300565 Chrom 485303965 Mattschwarz	486700565 Chrom 486703965 Mattschwarz	351010538 Chrom 351013938 Mattschwarz	485900565*** Chrom	484240565 Chrom
				6l Durchflussmenge 412980575 Chrom

				
Unterputz-Wannenfüll- und Brause-Einhandmischer	Unterputz-Wannenfüll- und Brause-Thermostatarmatur	PUSH Unterputz-Armatur	PUSH Unterputz-Thermostatarmatur	Wanneneinlauf DN 15
486590565**** Chrom 486593965**** Mattschwarz	388300545**** Chrom	387110538**** Chrom	ein Verbraucher 389010538**** Chrom	4860005 Chrom
486630565**** Chrom 486633965**** Mattschwarz			zwei Verbraucher 389110538**** Chrom	



			
Brause-Einhandmischer DN 15	Thermostat Brausearmatur DN 15	Unterputz-Brause-Einhandmischer	Unterputz-Brause-Thermostatarmatur
488700565 Chrom 488703965 Mattschwarz	351000538 Chrom 351003938 Mattschwarz	486550565**** Chrom 486553965**** Mattschwarz	388350545**** Chrom





\*benötigtes Zubehör: Elektronik-Körper mit Netzteil, Art.-Nr. 38001 oder Elektronik-Körper mit Batterie, Art.-Nr. 38002

\*\* benötigtes Zubehör: Elektronik-Körper mit Netzteil, Art.-Nr. 38003 oder Elektronik-Körper mit Batterie, Art.-Nr. 38004





\*\*\* benötigtes Zubehör: KLUDI FLEXX.BOXX, Art.-Nr. 88088 \*\*\*\* benötigtes Zubehör: KLUDI FLEXX.BOXX, Art.-Nr. 88011

## AMEO

				
Waschtisch-Einhandmischer DN 15	Waschtisch-Einhandmischer XL DN 15	Waschtisch-Einhandmischer DN 15	Waschschüssel-Einhandmischer DN 15 Auslaufhöhe 270 mm	Waschschüssel-Einhandmischer DN 15 Auslaufhöhe 205 mm
mit Ablaufgarnitur 410290575 Chrom	mit Ablaufgarnitur 410230575 Chrom	Push-Open-Ventil 410250575 Chrom	3,8l Durchflussmenge 412980575R Chrom	
ohne Ablaufgarnitur 410280575 Chrom	ohne Ablaufgarnitur 410260575 Chrom	ohne Ablaufgarnitur 410240575 Chrom	ohne Ablaufgarnitur 412980575 Chrom	ohne Ablaufgarnitur 412960575 Chrom

				
Unterputz-Waschtisch-Zweiloch-Wand-Einhandmischer	Waschtisch-Dreilocharmatur DN 15	Waschtisch-Dreilocharmatur DN 15	Bidet-Einhandmischer DN 15	Wannenfüll- und Brause-Einhandmischer DN 15
Ausladung 185 mm 412440575* Chrom	413930575 Chrom	413930530 Chrom	412160575 Chrom	414450575 Chrom
Ausladung 235 mm 412450575* Chrom				

				
Wannenfüll- und Brause-Einhandmischer DN 15	Wannenfüll- und Brause-Einhandmischer DN 15	Wannenfüll- und Brause-Einhandmischer DN 15	Wannenfüll- und Brausearmatur DN 15	Wannenfüll- und Brausearmatur DN 15
416710575 Chrom	414470575 Chrom	414480575 Chrom	414240575 Chrom	414240530 Chrom





				
Unterputz-Wannenfüll- und Brause-Einhandmischer	Unterputz-Wannenfüll- und Brause-Thermostatarmatur	PUSH Unterputz-Armatur	PUSH Unterputz-Thermostatarmatur	Wanneneinlauf DN 20
416590575** Chrom	418300575** Chrom	384110538** Chrom	ein Verbraucher 383010538** Chrom	4150505 Chrom
eigensicher gegen Rückfließen 416630575** Chrom			zwei Verbraucher 385110538** Chrom	

\* benötigtes Zubehör: Rohbau-Set DN 15, Art.-Nr. 38243 oder Art.-Nr. 38242 \*\* benötigtes Zubehör: KLUDI FLEXX.BOXX, Art.-Nr. 88011





## AMEO





			
Brause-Einhandmischer DN 15	Brause-Einhandmischer DN 15	Unterputz-Brause-Einhandmischer	Unterputz-Brause-Thermostatarmatur
417100575 Chrom	416750575 Chrom	416590575* Chrom	418850575* Chrom



## BALANCE

				
Waschtisch-Einhandmischer DN 15	Waschtisch-Einhandmischer DN 15 5l Durchflussmenge	Elektronische Waschtischarmatur DN 15 5l Durchflussmenge	Elektronische Waschtischarmatur DN 15 5l Durchflussmenge	Elektronische Waschtischarmatur DN 15 1,9l Durchflussmenge
mit Ablaufgarnitur 3,8l/min Durchflussmenge 520230575WR5 Chrom 520238775WR5 Mattschwarz / Chrom 520239175WR5 Weiß / Chrom	ohne Ablaufgarnitur 520260575 Chrom 520268775 Mattschwarz / Chrom 520269175 Weiß / Chrom	ohne Ablaufgarnitur 230V Netzgerät 5220005 Chrom  5220091 Weiß / Chrom	ohne Ablaufgarnitur 230V Netzgerät 5220205 Chrom	ohne Ablaufgarnitur 230V Netzgerät 5220005WR Chrom
8l/min Durchflussmenge 520230575 Chrom 520239175 Mattschwarz / Chrom 520238775 Weiß / Chrom		6V Lithium-Batterie 5210005 Chrom  5210091 Weiß / Chrom		6V Lithium-Batterie 5210005WR Chrom

				
Elektronisches Standventil DN 15 ohne Mischwelle + Temperaturwählgriff	Waschschüssel-Einhandmischer DN 15 Auslaufhöhe 270 mm	Waschschüssel-Einhandmischer DN 15 Auslaufhöhe 210 mm	Unterputz-Waschtisch-Zweiloch-Wand-Einhandmischer	Bidet-Einhandmischer DN 15
ohne Ablaufgarnitur 6V Lithium-Batterie 5210505 Chrom	ohne Ablaufgarnitur 3,8l/min Durchflussmenge 522980575WR5 Chrom 522988775WR5 Mattschwarz / Chrom 522989175WR5 Weiß / Chrom	ohne Ablaufgarnitur 8l/min Durchflussmenge 522960575 Chrom 522968775 Mattschwarz / Chrom 522969175 Weiß / Chrom	Ausladung 185 mm  522460575** Chrom 522468775** Mattschwarz / Chrom 522469175** Weiß / Chrom	mit Ablaufgarnitur 522160575 Chrom 5222960575 Mattschwarz / Chrom 522169175 Weiß / Chrom
	8l/min Durchflussmenge 522980575 Chrom 522989175 Mattschwarz / Chrom 522988775 Weiß / Chrom		Ausladung 235 mm 522470575** Chrom 522478775** Mattschwarz / Chrom	

				
Wannenfüll- und Brause-Einhandmischer DN 15	Wannenfüll- und Brause-Einhandmischer DN 15	Wannenfüll- und Brause-Einhandmischer DN 15	Unterputz-Wannenfüll- und Brause-Einhandmischer	Unterputz-Wannenfüll- und Brause-Thermostatarmatur
524450575 Chrom 524458775 Mattschwarz / Chrom 524459175 Weiß / Chrom	525900575* Chrom 525908775* Mattschwarz / Chrom 525909175* Weiß / Chrom	524470575 Chrom	526590575** Chrom	528300575** Chrom 528308775** Mattschwarz / Chrom
			eigensicher gegen Rückfließen 526630575* Chrom	

				
PUSH Unterputz-Armatur	Unterputz-Thermostatarmatur	Wanneneinlauf DN 20	Brause-Einhandmischer DN 15	Unterputz-Brause-Einhandmischer
387110538** Chrom	ein Verbraucher 389010538** Chrom	5250305 Chrom 5250387 Mattschwarz / Chrom 5250391 Weiß / Chrom	527100575 Chrom 527108775 Mattschwarz / Chrom 527109175 Weiß / Chrom	527550575** Chrom 527558775** Mattschwarz / Chrom 527559175** Weiß / Chrom
	zwei Verbraucher 389110538** Chrom			

			
Unterputz-Thermostatarmatur DN 20	Drei-Wege-Umstellung	Zwei-Wege-Umstellung	Unterputzventil
527390575** Chrom	528460575*** Chrom	528470575**** Chrom	528150575***** Chrom

## PURE&EASY

				
Waschtisch-Einhandmischer 60 DN 15	Waschtisch-Einhandmischer 60 DN 15	Waschtisch-Einhandmischer 70 DN 15	Waschtisch-Einhandmischer 70 DN 15	Waschtisch-Einhandmischer 70 DN 15 Mittelstellung Kaltwasser
Ablaufgarnitur Kunststoff 372850565 Chrom		Ablaufgarnitur Kunststoff 372820565 Chrom		
Ablaufgarnitur Metall 373850565 Chrom	ohne Ablaufgarnitur 373870565 Chrom	Ablaufgarnitur Metall 373820565 Chrom 373829165 Weiß / Chrom	ohne Ablaufgarnitur 370280565 Chrom 370289165 Weiß / Chrom	Ablaufgarnitur Metall 372890565 Chrom

\*benötigtes Zubehör: KLUDI FLEXX.BOXX, Art.-Nr. 88011 \*\*benötigtes Zubehör: KLUDI FLEXX.BOXX, Art.-Nr. 88011

\*\*\* benötigtes Zubehör: Bausatz-Vormontage, Art.-Nr. 29757 \*\*\*\* benötigtes Zubehör: Bausatz-Vormontage, Art.-Nr. 29747

\*\*\*\*\* benötigtes Zubehör: Unterputzventil Art.-Nr. 53811

\* benötigtes Zubehör: KLUDI FLEXX.BOXX, Art.-Nr. 88011 \*\* benötigtes Zubehör: Rohbau-Set DN 15, Art.-Nr. 38243

**PURE&EASY**

				
Waschtisch-Einhandmischer 70 DN 15 5l Durchflussmenge	Waschtisch-Einhandmischer 70 DN 15 3,8l Mittelstellung Kaltwasser	CARE Waschtisch-Einhandmischer 70 DN 15 Public-Armhebel	CARE Waschtisch-Einhandmischer 70 DN 15 Klinik-Armhebel	Waschtisch-Einhandmischer 100 DN 15
Ablaufgarnitur Kunststoff 372750565 Chrom	ohne Ablaufgarnitur 373890565WR4 Chrom	372840565 Chrom	3,8l Durchflussmenge 372870565WR5 Chrom	Ablaufgarnitur Kunststoff 371900565 Chrom
Ablaufgarnitur Metall 372760565 Chrom	Ablaufgarnitur Metall 373880565WR4 Chrom		7l Durchflussmenge 372870565 Chrom	Ablaufgarnitur Metall 372900565 Chrom 372909165 Weiß / Chrom





				
Waschtisch-Einhandmischer 100 DN 15	Waschtisch-Einhandmischer 100 DN 15 3,8l Durchflussmenge	Waschtisch-Einhandmischer 70 DN 15 Mittelstellung Kaltwasser	Waschtisch-Einhandmischer 70 DN 15 3,8l Durchflussmenge	Waschtisch-Einhandmischer DN 15
ohne Ablaufgarnitur 372920565 Chrom 372929165 Weiß / Chrom	Ablaufgarnitur Kunststoff 371900565WR5 Chrom	ohne Ablaufgarnitur 371980565WR4 Chrom	Ablaufgarnitur Kunststoff 372820565R Chrom	ohne Ablaufgarnitur 370240565 Chrom
	Ablaufgarnitur Metall 372900565WR5 Chrom	Ablaufgarnitur Metall 372930565WR4 Chrom	Ablaufgarnitur Metall 373820565WR5 Chrom	Ablaufgarnitur Metall 370230565 Chrom





			
Bidet-Einhandmischer DN 15	Wannenfüll- und Brause-Einhandmischer DN 15	Wannenfüll- und Brause-Einhandmischer DN 15	Unterputz-Wannenfüll- und Brause-Einhandmischer
3,8l Durchlaufmenge 375330565R Chrom	376810565 Chrom 376819165 Weiß / Chrom	375910565 Chrom	376590565* Chrom
6l Durchlaufmenge  375330565 Chrom 375339165 Weiß / Chrom		mit Tele-Handbrause  375920565 Chrom	eigensicher gegen Rückfließen 376630565* Chrom

**PURE&SOLID**

				
Waschtisch-Einhandmischer 60 DN 15	Waschtisch-Einhandmischer 75 DN 15	Waschtisch-Einhandmischer 75 DN 15	Waschtisch-Einhandmischer 75 DN 15 Mittelstellung Kaltwasser	Waschtisch-Einhandmischer 100 DN 15
343850575 Chrom	343820575 Chrom	3,8l Durchflussmenge 343820575WR5 Chrom	343880575WR4 Chrom	342900575 Chrom
	ohne Ablaufgarnitur 340280575 Chrom	5l Durchflussmenge 342760575 Chrom	ohne Ablaufgarnitur 343890575WR4 Chrom	ohne Ablaufgarnitur 342920575 Chrom

\* benötigtes Zubehör: KLUDI FLEXX.BOXX, Art.-Nr. 88011

				
Waschtisch-Einhandmischer 100 DN 15 Mittelstellung Kaltwasser	Waschtisch-Einhandmischer 100 DN 15 3,8l Durchflussmenge	Waschtisch-Einhandmischer DN 15 5l Durchflussmenge	Waschtischarmatur DN 15	Bidet-Einhandmischer DN 15
342930575WR4 Chrom	342900575WR5 Chrom	340250575 Chrom	343940575 Chrom	342160575 Chrom
ohne Ablaufgarnitur 341980575WR4		ohne Ablaufgarnitur 340240575		

				
Wannenfüll- und Brause-Einhandmischer DN 15	Wannenfüll- und Brausearmatur DN 15	Unterputz-Wannenfüll- und Brause-Einhandmischer	Brause-Einhandmischer DN 15	Unterputz-Brause-Einhandmischer
346810575 Chrom	344230575 Chrom	346590575* Chrom	348410575 Chrom	346550575* Chrom
		eigensicher gegen Rückfließen 346630575* Chrom		

**PURE&STYLE**

				
Waschtisch-Einhandmischer 60 DN 15	Waschtisch-Einhandmischer 75 DN 15	Waschtisch-Einhandmischer 75 DN 15 Mittelstellung Kaltwasser	Waschtisch-Einhandmischer 100 DN 15	Waschtisch-Einhandmischer 100 DN 15 Mittelstellung Kaltwasser
403850575 Chrom	403820575 Chrom 403823975 Mattschwarz	403880575WR4 Chrom 403883975 Mattschwarz	402900575 Chrom 402903975 Mattschwarz	402930575WR4 Chrom 402933975 Mattschwarz
	ohne Ablaufgarnitur 400280575 Chrom 400283975 Mattschwarz	ohne Ablaufgarnitur 403890575WR4 Chrom 403893975 Mattschwarz	ohne Ablaufgarnitur 402920575 Chrom 402923975 Mattschwarz	ohne Ablaufgarnitur 401980575WR4 Chrom 401983975 Mattschwarz

				
Waschschüssel-Einhandmischer DN 15	Waschtisch-Einhandmischer 75 DN 15 3,8l Durchflussmenge	Waschtisch-Einhandmischer 100 DN 15 3,8l Durchflussmenge	Waschtisch-Einhandmischer DN 15 5l Durchflussmenge	Bidet-Einhandmischer DN 15
7l Durchflussmenge 402960575 Chrom 402963975 Mattschwarz	403820575WR5 Chrom	402900575WR5 Chrom	400250575 Chrom	402160575 Chrom
3,8l Durchflussmenge 402960575WR5 Chrom			ohne Ablaufgarnitur 400240575 Chrom 400243975 Mattschwarz	

\* benötigtes Zubehör: KLUDI FLEXX.BOXX, Art.-Nr. 88011

## PURE&STYLE

			
Wannenfüll- und Brause-Einhandmischer DN 15	Unterputz-Wannenfüll- und Brause-Einhandmischer	Brause-Einhandmischer DN 15	Unterputz-Brause-Einhandmischer
406810575 Chrom 406813975 Mattschwarz	406590575* Chrom 406593975* Mattschwarz	408410575 Chrom 408413975 Mattschwarz	406550575* Chrom 406553975* Mattschwarz
eigensicher gegen Rückfließen 406630575* Chrom 406633975* Mattschwarz			

## SHOWER SYSTEME

### COCKPIT Discovery



Thermostat Dual Shower System DN 15

8020091-00 Weiß/ Chrom

### COCKPIT Explorer



Thermostat Dual Shower System DN 15

8005005-00 Chrom

### FRESHLINE



Thermostat Dual Shower System DN 15 Brauseschlauch

16,4l Durchflussmenge  
6709205-00 Chrom

8l Durchflussmenge  
6709205-00WR9 Chrom



Dual Shower System DN 15

14l Durchflussmenge  
6709005-00 Chrom

8l Durchflussmenge  
6709005-00WR9 Chrom

### LOGO



Thermostat Dual Shower System DN 15

3S Handbrause DN 15  
6809205-00 Chrom  
6808239-00 Mattschwarz

1S Handbrause DN 15  
6809505-00 Chrom



Einhandmischer Dual Shower System DN 15

mit Wanneneinlauf  
6808305-00 Chrom

18l Durchflussmenge  
6808505-00 Chrom



Einhandmischer Dual Shower System DN 15

8l Durchflussmenge  
6808505-00WR9

6l Durchflussmenge  
6808505-00WR6 Chrom



Dual Shower System DN 15

3S Handbrause DN 15  
6809105-00 Chrom

1S Handbrause DN 15  
6809305-00 Chrom

### LOGO SHOWER DUO



Shower Duo

900mm  
6857805-00 Chrom

600mm  
6857505-00 Chrom

## DIVE



Thermostat Dual Shower System sDive 3S

6807905-00 Chrom



Dual Shower System sDive 3S

6808005-00 Chrom



Thermostat Dual Shower System xDive 3S

6907905-00 Chrom



Dual Shower System xDive 3S

6908005-00 Chrom

## HANDBRAUSEN

### DIVE



Handbrause sDive 1S

6881005-00 Chrom



Handbrause sDive 3S

6883005-00 Chrom



Handbrause xDive 1S

6981005-00 Chrom



Handbrause xDive 3S

6983005-00 Chrom

### NOVA FONTE



Handbrause 1S DN 15

3912005-00 Chrom  
3912039-00 Mattschwarz  
3912053-00 Mattweiß

### FRESHLINE



Handbrause CL 1S

22l Durchflussmenge  
6450005-00 Chrom



Handbrause RL 3S

19l Durchflussmenge  
6790005-00 Chrom

6790043-00 Weiß

9l Durchflussmenge  
6790005-00WR9 Chrom



Handbrause RS 1S

29l Durchflussmenge  
6780005-00 Chrom

6780043-00 Weiß

9l Durchflussmenge  
6780005-00WR9 Chrom



Handbrause RS 1S

5l Durchflussmenge  
6780005R-00 Chrom

### LOGO



Handbrause 1S DN 15

41l Durchflussmenge  
6810005-00 Chrom

9l Durchflussmenge  
6810005-00WR9 Chrom



Handbrause 1S DN 15

5l Durchflussmenge  
6810005R-00 Chrom

9l Durchflussmenge  
6830005-00WR9 Chrom



Handbrause 3S DN 15

13l Durchflussmenge  
6830005-00 Chrom  
6830039-00 Mattschwarz

9l Durchflussmenge  
6830005-00WR9 Chrom



## BRAUSESETS/ -STANGEN

### DIVE



Handbrause sDive 1S

900 mm  
6891005-00 Chrom

600 mm  
6861005-00 Chrom



Handbrause sDive 3S

900 mm  
6893005-00 Chrom

600 mm  
6863005-00 Chrom



Brause-Set xDive 1S

900 mm  
6991005-00 Chrom

600 mm  
6961005-00 Chrom



Brause-Set xDive 3S

900 mm  
6993005-00 Chrom

600 mm  
6963005-00 Chrom



Wannen-Brause-Set  
sDive 1S

6885005-00 Chrom

### LOGO



Brause-Set 1S

955 mm  
6864205-00 Chrom

600 mm  
6783005-00 Chrom



Brause-Set 3S  
900 mm

6839305-00 Chrom

600 mm  
6783005-00 Chrom



Brause-Set 3S  
600 mm

13l Durchflussmenge  
6836305-00 Chrom

8l Durchflussmenge  
6836305-00WR9 Chrom



Brause-Set 1S  
900 mm

6819005-00 Chrom

600 mm  
6816005-00WR9 Chrom



Brause-Set 1S  
600 mm

23l Durchflussmenge  
6816005-00 Chrom

8l Durchflussmenge  
6816005-00WR9 Chrom

### NOVA FONTE



Wannen-Brause-Set  
sDive 3S

6895005-00 Chrom



Wannen-Brause-Set  
xDive 1S

6985005-00 Chrom



Wannen-Brause-Set  
xDive 3S

6995005-00 Chrom

600 mm  
6863005-00 Chrom



Brause-Set 1S  
Puristic

2084005-15 Chrom  
2084039-15 Mattschwarz  
2085053-15 Mattweiß



Brause-Set 1S  
Classic

2084005-25 Chrom



Wannen-Brause-Set 1S

6801005-00 Chrom

Wandanschlussbogen  
mit Brausehalter DN 15  
6867005-00 Chrom



Wannen-Brause-Set 3S

6803005-00 Chrom

### NOVA FONTE



Brause-Set 1S  
Déco

2084005-35 Chrom



Wannen-Brause-Set 1S  
Puristic

2085005-15 Chrom  
2085039-15 Mattschwarz  
2085053-15 Mattweiß



Wannen-Brause-Set 1S  
Classic

2085005-25 Chrom



Wannen-Brause-Set 1S  
Déco

2085005-35 Chrom

### A-QA



flexible Wandstange

6209505-00 Chrom



Wandstange

6564105-00 Chrom

### 1926



Brause-Set

2710305 Chrom  
2710345 23kt vergoldet



Brausegarnitur DN 15

2710505 Chrom  
2710545 23kt vergoldet

### FRESHLINE



Brause-Set 3S

900 mm  
6794005-00 Chrom

6794091-00 Weiß / Chrom



Brause-Set 3S  
600 mm

15l Durchflussmenge  
6793005-00 Chrom

8l Durchflussmenge  
6793005-00WR9 Chrom



Brause-Set 1S

900 mm  
6784005-00 Chrom

6784091-00 Weiß / Chrom

600 mm  
6783005-00 Chrom



Wannen-Brause-Set 3S

6795005-00 Chrom

6795091-00 Weiß / Chrom



Wannen-Brause-Set 1S

23l Durchflussmenge  
6785005-00 Chrom

19l Durchflussmenge  
6787005-00 Chrom  
6787091-00 Weiß / Chrom

## KOPFBRAUSEN

### FRESHLINE



Kopfbrause DN 15

400 x 260 mm  
6440005-00 Chrom





300 x 220 mm  
6445005-00 Chrom













Tellerkopfbrause DN 15

6751105-00 Chrom

**A-QA**

				
Kopfbrause DN 15 24,5l Durchflussmenge 6487005-00 Chrom	Kopfbrause DN 15 zwei Strahlarten 6488005-00 Chrom 6488087-00 Mattschwarz/ Chrom 6488091-00 Weiß / Chrom	Tellerkopfbrause DN 15 200 mm 23l Durchflussmenge 6432005-00 Chrom	Tellerkopfbrause DN 15 250 mm 23l Durchflussmenge 6432505-00 Chrom 6432587-00 Mattschwarz/ Chrom 6432591-00 Weiß / Chrom	Tellerkopfbrause DN 15 300 mm 23l Durchflussmenge 6433005-00 Chrom 6433087-00 Mattschwarz/ Chrom 6433091-00 Weiß / Chrom 6433053-00 Mattweiß
8l Durchflussmenge 6487005-00WR9 Chrom		8l Durchflussmenge 6432005-00WR9 Chrom	8l Durchflussmenge 6432505-00WR9 Chrom	8l Durchflussmenge 6433005-00WR9 Chrom

				
Kopfbrause DN 15 400 mm 23l Durchflussmenge 6434005-00 Chrom 6434087-00 Mattschwarz/ Chrom 6434091-00 Weiß / Chrom	Kopfbrause DN 15 200x200 mm 11l Durchflussmenge 6442005-00 Chrom	Kopfbrause DN 15 250x250 mm 23l Durchflussmenge 6442505-00 Chrom  6442591-00 Weiß / Chrom	Kopfbrause DN 15 300x300 mm 23l Durchflussmenge 6443005-00 Chrom  6443091-00 Weiß / Chrom	Kopfbrause DN 15 400x400 mm 23l Durchflussmenge 6444005-00 Chrom  6444091-00 Weiß / Chrom
8l Durchflussmenge 6434005-00WR9 Chrom	8l Durchflussmenge 6442005-00WR9 Chrom	8l Durchflussmenge 6442505-00WR9 Chrom	8l Durchflussmenge 6443005-00WR9 Chrom	9l Durchflussmenge 6444005-00WR9 Chrom

				
Kopfbrause DN 15 200x200 mm soft-edge 6452005-00 Chrom	Kopfbrause DN 15 300x300 mm soft-edge 14l Durchflussmenge 6453005-00 Chrom 6453091-00 Weiß / Chrom	Tellerkopfbrause DN 15 245 mm 6651105-00 Chrom	Eco Tellerkopfbrause DN 15 245 mm 6652105-00 Chrom	Kopfbrause DN 15 140x245 mm 22,5l Durchflussmenge 4940205-00 Chrom
	8l Durchflussmenge 6453005-00WR9 Chrom	200 mm 6651005-00 Chrom		8l Durchflussmenge 4940205-00WR9 Chrom

**1926**

			
Kopfbrause DN 15 200x200 mm Geräuschkategorie I 25,8l Durchflussmenge 6653005-00 Chrom	Kopfbrause DN 15 250x250 mm Geräuschkategorie I 42l Durchflussmenge 6653105-00 Chrom	Kopfbrause DN 15 6219105-00 Chrom	Kopfbrause DN 15 2751005 Chrom 2751045 23kt vergoldet
9l Durchflussmenge 6653005-00WR9 Chrom	9l Durchflussmenge 6654105-00 Chrom		8l Durchflussmenge 6757805-00WR9 Chrom





**ZUBEHÖR**

**A-QA**

				
Brausearm DN 15 Schubrosette 58x58 mm Ausladung 400 mm 6654405-00 Chrom	Brausearm DN 15 Schubrosette Ø 55 mm Ausladung 400 mm 6651405-00 Chrom 6651487-00 Mattschwarz/ Chrom 6651439-00 Mattschwarz 6651491-00 Weiß / Chrom 6651453-00 Mattweiß	Brausearm DN 15 Schubrosette 61x61 mm Ausladung 400 mm 6653405-00 Chrom  6653491-00 Weiß / Chrom	Brausearm DN 15 6235305-00 Chrom	Deckenauslass DN 15 Schubrosette 58x58 mm 6654505-00 Chrom
Ausladung 250 mm 6654305-00 Chrom	Ausladung 250 mm 6651305-00 Chrom	Ausladung 250 mm 6653305-00 Chrom		

**1926**

**COCKPIT**

			
Brausearm DN 15 Schubrosette Ø 55 mm 6651505-00 Chrom 6651587-00 Mattschwarz/ Chrom 6651539-00 Mattschwarz 6651591-00 Weiß / Chrom	Brausearm DN 15 Schubrosette 61x61 mm 6653505-00 Chrom  6653591-00 Weiß / Chrom	Brausearm DN 15 2751405 Chrom  2751445 23kt vergoldet	Ablage 6410110-00

